

# VACMASTER<sup>®</sup>

## OPERATOR'S GUIDE

VP325 Chamber Machine  
Commercial Vacuum Packaging System



## **Congratulations on your purchase of the VacMaster® VP325 Chamber Machine!**

Thank you for purchasing the VacMaster® VP325 Chamber Machine. The VP325 is designed as a commercial grade vacuum packaging system and can be used for a wide variety of products. With the VP325 you can extend food life, maintain food quality, reduce freezer burn and reduce food waste and costs.

The VacMaster® VP325 is a chamber vacuum system, which offers two distinct advantages over non-chamber, external bag type units. First, a much higher level of vacuum can be achieved which means a longer shelf life for foods that you package. Secondly, liquids and liquid-rich foods can be effectively vacuum packaged. Food products like fresh meats, fish, soups, stews, etc. are no longer a problem to vacuum package. Marinated vegetables and meats are packaged quickly with ease, and no mess.

The VP325 Chamber Machine uses commercial technology. Simply place the pouch to be sealed inside the chamber and close the lid. This activates the vacuum pump and the vacuum and sealing process begins! First, the air is removed from the entire chamber and the vacuum pouch. Once the preset vacuum level is achieved, the pouch is sealed. Upon completion of the sealing cycle, the air flows back into the chamber and the lid opens automatically.

### **Use the VP325 to:**

- Vacuum package soups, stews and other liquid foods.
- Keep fish and game meat fresh longer and free of freezer burn.
- Store meat and fish scent-free.
- Take advantage of bulk buys. Simply portion and package.
- Perfect for marinating meat and vegetables.
- Vacuum package pre-made meals.
- Prevent oxidation and damage to rare coins, silverware and important documents.

Read and follow all directions for usage and maintenance carefully and you'll benefit from years of trouble-free and cost effective vacuum packaging.

***Call us at 800.821.7849 for questions regarding the machines or vacuum pouches.***

# **STOP!!**

**Read and complete the following to prevent any damage.**  
**Oil must be added to the vacuum pump before using.**

VacMaster® model VP325 uses an oil vacuum pump.  
For shipping purposes there is no oil in the pump. Oil must be added.

## Adding Oil to Vacuum Pump

**Turn off and unplug machine to prevent electrocution.**

1. Using the included ARY approved oil, fill the enclosed plastic oil bottle.
2. With a phillips screwdriver, remove the 4 screws to open the back of the cabinet.
3. Locate the oil fill cap on the top of the vacuum pump.
4. With pliers or vice grips, turn cap counterclockwise to loosen & remove.
5. Watching site glass, insert end of oil bottle into hole.
6. Fill oil level between 1/2 to 3/4 of site glass; approximately 8oz. of oil.  
*Do not overfill. Overfill can cause damage to the vacuum pump.*
7. Replace and tighten oil fill cap to vacuum pump.
8. Reattach back cover.

***NOTE:*** Pump requires approximately 8 fluid ounces of oil (approx. 1 cup).  
Use only approved VacMaster® vacuum oil.

Back of Housing Cabinet



Oil Site Glass

Oil Fill Cap

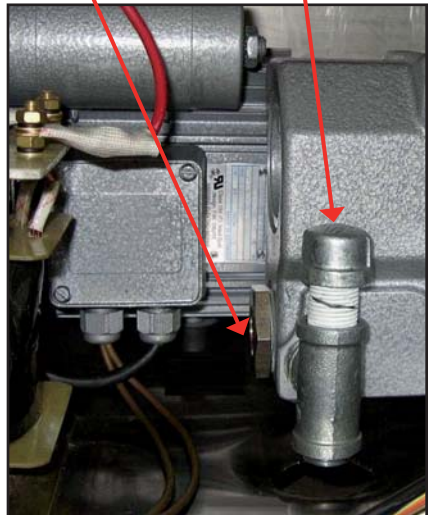

## Packaging Information

With the VP325, you can easily package a wide variety of sizes and shapes. You can also prep and store smaller individual serving portions as well as bulk items.

- Keeps food fresh 3-5 times longer than conventional storage bags.
- Several sizes available to meet your packaging needs.
- Terrific for hundreds of applications in and out of the kitchen
- Safe for freezer, refrigeration, and microwave use. Cook in bags can be boiled.
- Bag thickness available in standard 3mil or heavy duty 4mil.
- Bags are economically priced, giving you a better value.

The chamber of the VP325 can easily vacuum package the following sizes of vacuum pouches:

Size	Quantity	Thickness	Pouch Type	Part Number
2.5" x 10"	2000	3mil	Standard	30765
6" x 7"	1000	3mil	Standard	30766
6" x 8"	1000	3mil	Standard	30742
6" x 8.5"	1000	3mil	Standard	30720
6" x 8.5"	1000	3mil	Cook in	30750
6" x 10"	1000	3mil	Standard	30721
6" x 10"	200	3mil	Standard	30721RB
6" x 12"	1000	3mil	Standard	30743
6" x 15"	1000	3mil	Standard	30787
7" x 9"	1000	3mil	Standard	30788
7" x 11"	1000	3mil	Standard	30789
7" x 12"	1000	3mil	Standard	30791
8" x 10"	1000	3mil	Standard	30722
8" x 10"	200	3mil	Standard	30722RB
8" x 12"	1000	3mil	Standard	30723
8" x 12"	1000	4mil	Standard	30754
8" x 12"	1000	3mil	Cook in	30751
8" x 15"	1000	3mil	Standard	30744
8" x 20"	1000	4mil	Standard	30767
10" x 10"	1000	3mil	Standard	30724
10" x 13"	1000	3mil	Standard	30725

Size	Quantity	Thickness	Pouch Type	Part Number
10" x 13"	100	3mil	Standard	30725RB
10" x 13"	1000	4mil	Standard	30778
10" x 15"	1000	3mil	Standard	30726
10" x 15"	1000	3mil	Cook in	30749
10" x 16"	1000	4mil	Standard	30755
10" x 16"	1000	3mil	Cook in	30752
10" x 18"	500	3mil	Standard	30745
10" x 20"	500	4mil	Standard	30756
10" x 22"	500	3mil	Standard	30729
12" x 12"	1000	3mil	Standard	30727
12" x 14"	1000	3mil	Standard	30728
12" x 14"	100	3mil	Standard	30728RB
12" x 15"	500	3mil	Standard	30746
12" x 16"	500	3mil	Standard	30731
12" x 16"	500	4mil	Standard	30786
12" x 18"	500	3mil	Standard	30732
12" x 18"	500	4mil	Standard	30757
12" x 22"	500	3mil	Standard	30733
14" x 16"	500	3mil	Standard	30734
14" x 18"	500	3mil	Cook in	30753
14" x 20"	500	3mil	Standard	30735



## Getting Started with Vacuum Packaging

If you are part of the food processing or food service industry, there is a good chance that you already know the advantages of vacuum packaging. It has been used with success for many years as a safe and cost effective method for extending shelf life and maintaining the quality of food products. If vacuum packaging is new to your home or business, you will soon wonder how you lived without it!

Whether you are a beginner or expert, there are certain basic guidelines that should always be followed in order to package foods safe to eat. Neglecting these basic guidelines can result in food spoilage, and in some cases, illness or death.

Once you familiarize yourself with the VP325 and the procedures, you will feel at ease using the VacMaster® Chamber Machine and enjoy a higher quality of stored foods.

- Package only fresh foods. Do not package old or rancid foods. An already bad product does not improve with vacuum packaging.
- Fresh foods (Meats, vegetables, cheeses, etc.) should be refrigerated at 34°F or below or frozen after vacuum packaging.
- Vacuum packaging removes a high percentage of air (which is 21% oxygen). This slows the growth of most living microorganisms, which degrade food, such as aerobic bacteria and molds. However, some forms of bacteria such as clostridium botulinum (responsible for botulism) are anaerobic and grow in the absence of oxygen.
- The foods susceptible to botulinum should be refrigerated for a short term and frozen for long-term storage. Consume immediately after heating.
- Vegetables such as cauliflower, broccoli and cabbage will emit gasses when vacuum sealed. To prepare these foods for vacuum packaging, you must blanch them first.
- All perishable foods must be refrigerated or frozen to prevent spoilage.
- Vacuum packaging is not a substitute for heat canning.

## Safety Precautions

For your safety, follow these precautions when using your VacMaster® VP325:

- Read Operator's Guide carefully before using the machine for the first time.
- Do not use the VP325 on wet or hot surfaces, or near a heat source.
- Do not immerse machine or power cord in water or any other liquid.
- Plug VP325 into grounded power sources only.  
Do not use extension cord.
- To disconnect, unplug directly from power source. Do not disconnect by pulling cord.
- Do not operate machine with damaged power cord.
- Only use VacMaster® vacuum pouches and accessories.
- Do not allow to be used as a toy. Close supervision is necessary when used by or near children.
- Only use VP325 for its intended use.

### **Gas Flush System**

Products which would be damaged by high pressure must be subjected to a lower vacuum or the pressure must be counterbalanced by inflating the bag with inert gas.

The gas flush system is designed to remove the oxygen and replace it with a mixture of Carbon Dioxide and Nitrogen to extend shelf life and provide a higher quality product to the consumer. This is beneficial when packaging items that shouldn't be compressed. This includes but is not limited to soft fruits, dried foods, chips, pasta, and pre-cooked meals. By adding a mixture of Carbon Dioxide and Nitrogen, the food will stay fresh longer while keeping its original shape.

### ***How To Use:***

Consult your local authorized gas supplier for assistance in buying, regulating, and connecting the gas to the machine.

### ***Gas Fill Operating Instructions:***

Connect the required gas cylinder, (complete with regulator), to the machine by hose. The Regulator may never be set more than atmospheric pressure, approximately 14 psi. The appropriate level should be between 5 and 12 psi.

To add gas flush to the normal operating cycle, follow the operating instructions. If there is no gas flush time set, there will be no gas flush in the process of sealing. To use the gas flush add increments of .1 seconds to the timer. It may take several adjustments to get the package to the desired fill level.



## Features of VP325

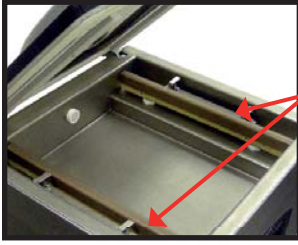

Seal Bars



\*Filler Plates



Silicone Bars

Control Panel

Power Switch

\*Lid Lock

\*Lid Lock Feature: not to be used during the vacuuming cycle. Used to keep lid closed when machine is not in use or while machine is in storage.

\*Filler Plates: used to "take up space" in the vacuum chamber. Using the plates will result in a faster vacuum time since there is less air to be removed from chamber. Can also be used to keep product centered on the seal bar and preventing liquids from escaping.

# Operating Instructions

## 1. Select the Pouch

Select the proper size VacMaster barrier vacuum pouch. Allow a minimum of 1" to 2" of extra headspace at the top of the pouch to ensure a quality, positive seal.

## 2. Plug in machine and switch power "ON"

The "WORKING" indicator light on the control panel will illuminate when the power is on.



## 3. Adjust / Set Timing Controls

All adjustments must be made with lid in the OPEN position.

- ~ **Vacuum Time:** Press the "SET" button once and you will notice the "VACUUM" indicator will light. Adjust the vacuum time "up" or "down" by using the "+" or "-" buttons. For initial test set the vacuum time to 25 seconds. Adjust vacuum accordingly to achieve the vacuum required.
- ~ **Gas Flush:** Press the "SET" button until the "GAS FLUSH" indicator lights. Adjust the gas flush time by using the "+" or "-" buttons. For an initial test, set to .1 second. Adjust accordingly to ensure a proper modified atmosphere.
- ~ **Sealing Time:** Press the "SET" button until the "SEALING" indicator lights. Adjust the sealing time "up" or "down" using the "+" or "-" buttons. For initial test set the sealing time to 1.2 seconds. Adjust sealing time accordingly to achieve a positive seal.
- ~ **Cooling Time:** Press the "SET" button until the "COOLING" indicator lights. Adjust the cooling time "up" or "down" using the "+" or "-" buttons. For initial test set the cooling time to 2.0 seconds.
- ~ Press "SET" until all setting lights are clear and the machine is ready to work. "ED" will appear on display.



#### 4. Fill pouch and place in Chamber

- Remove or replace filler plate to accommodate the product to be vacuumed.
- Always use as many filler plates as possible. Lay the pouch flat in the chamber with the opening of the pouch across the seal bar.
- Opening should extend across the seal bar by ½” to 1”. Make sure the opening is flat and wrinkle-free.

**Note: the entire pouch must remain inside the chamber.**

#### 5. Close lid

Hold down firmly until vacuum engages.

#### 6. Process

Closing the lid begins the vacuum cycle.

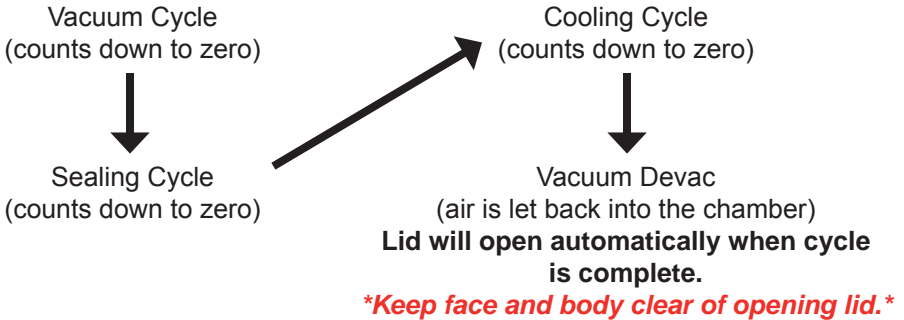

#### 7. Remove pouch & inspect

*Vacuum* – check the quality of the vacuum by looking at the tightness of the pouch and the product. If you notice “air pockets” increase the vacuum time by a few seconds, test again.

*Seal* – Inspect the pouch seal.

**Note: A positive seal will look “clear” upon inspection. If the seal is “spotty or incomplete” increase the sealing time by 0.2 seconds. If the seal is “white or milky” decrease seal time by 0.2 seconds.**

Additional Controls:



##### **Vacuum Gauge**

Represents the vacuum level inside the chamber.



##### **STOP Button**

Stops the vacuum cycle and the pouch will be sealed immediately. This feature can be used to eliminate or minimize product from escaping the pouch during Vacuum. It can also be used to control the vacuum level when packaging softer, fragile items.



##### **Seal Bar Temperature Setting**

Allows quick adjustments to the sealing temperature. Adjust the temperature upon pouch seal inspection.

## Changing/Replacing Oil in Vacuum Pump

1. Run vacuum process a couple of times to “warm up” the oil.
2. Turn off machine and unplug to prevent electrocution.
3. With a phillips screwdriver, remove the 4 screws to open the back of the cabinet.
4. Locate drain plug on underneath side of vacuum pump. Remove plug using 3/8” allen wrench, turning counter clockwise.
5. For access and ease of draining the oil, position machine so the drain bolt is “clear” and the dirty oil can be captured.
6. Oil will flow immediately when bolt is removed. Place catch cup underneath before removing drain bolt.
7. Capture oil from pump. When oil is completely drained, replace and tighten bolt. (Dispose of old oil properly, according to your local and state regulations.)
8. Follow the “Adding Oil to Vacuum Pump” instructions at beginning of manual. Do not use machine until oil has been added.

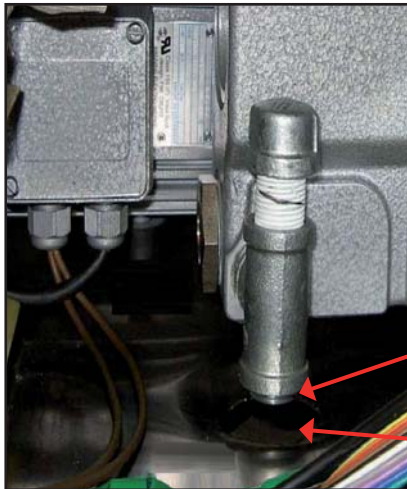

## Vacuum Pump Maintenance

The VP325 vacuum pump requires periodic oil changes. Required oil change schedule:

- First oil change: after 25 hours of VP325 usage.
- Future oil changes: change oil after every 60 hours of machine usage.

Using pump site glass, check the oil level and color frequently.

- Oil must remain between **1/2 and 3/4** of site glass.
- With use, the pump oil will become cloudy, dark or even “milky”. Once oil becomes discolored, change oil replacing with new VacMaster® vacuum oil.

## **Care, Maintenance & Troubleshooting**

The VacMaster® machines have been designed with ease of use and low maintenance in mind. Follow these few points for years of trouble-free operation:

### **Cleaning**

- UNPLUG your Chamber Machine before cleaning.
- Regularly clean machine with damp cloth removing any food debris.
- Use only a mild soap or stainless steel cleaner.
- DO NOT use any acetone-based or abrasive cleaner on the lid or other plastic parts. Parts will scratch and discolor.
- Wipe the seal bar with damp cloth only. NOTE: Seal bar is removable for safe cleaning.

### **Maintenance**

Periodically inspect the following items:

- Seal bar – inspect the brown Teflon tape covering the seal wire. If the tape becomes burnt or torn, replace.
- Lid gasket - make sure gasket and the top of the chamber remains clean and free of debris.

### **Troubleshooting**

Nothing happens when lid is closed:

1. Make sure power cord is firmly plugged into the electrical outlet.
2. Make sure the power switch is turned “ON”.
3. Make sure the power switch is not damaged in any way.
4. Plug in a different appliance to verify outlet is good.

Low vacuum (vacuum gauge not reading in the “green”):

1. Make sure the open end of the pouch is inside the chamber.
2. Confirm that the lid gasket and sealing area are clean and free of debris.
3. Increase the vacuum cycle time.

***Please read the owners manual carefully for a full understanding of your appliance.***

***Call 800.821.7849 for questions and troubleshooting.***

Fig. 1

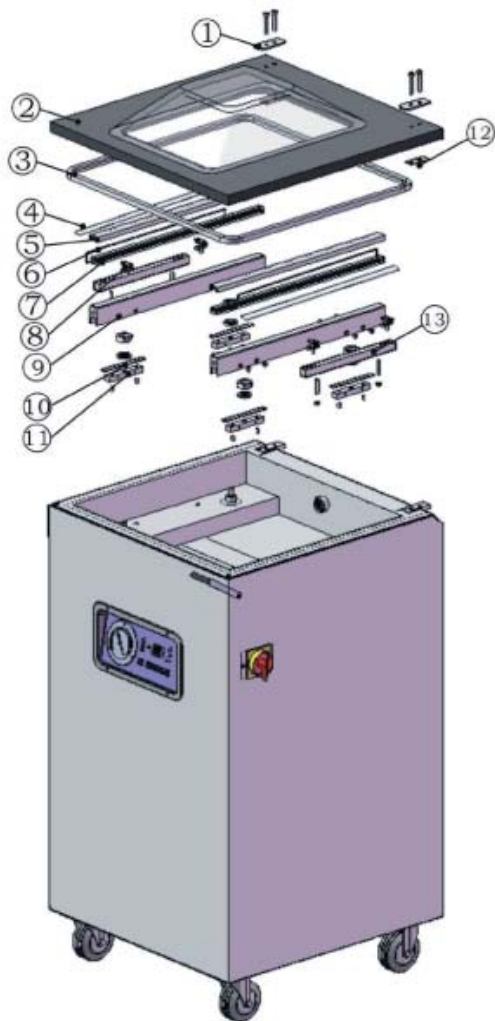

	Name	Quantity	Part Number	Assembly Part Number
1	Upper Platen for Lid	2		
2	Chamber Lid	1	979301	
3	Lid Gasket	1	979202	
4	Teflon Tape	2	979822	
5	Top Bar	2	979305	
6	Seal Pad	2	976598	
7	Seal Wire	2	979109	
8	Clamp	4		Seal Bar Assembly (979300)
9	Seal Bar	2		
10	Brass Contacts	4		
11	Seal Bar Tension Blocks	4		
12	Lower Platen for Lid	2		
13	Gas Flush	2		

Fig. 2

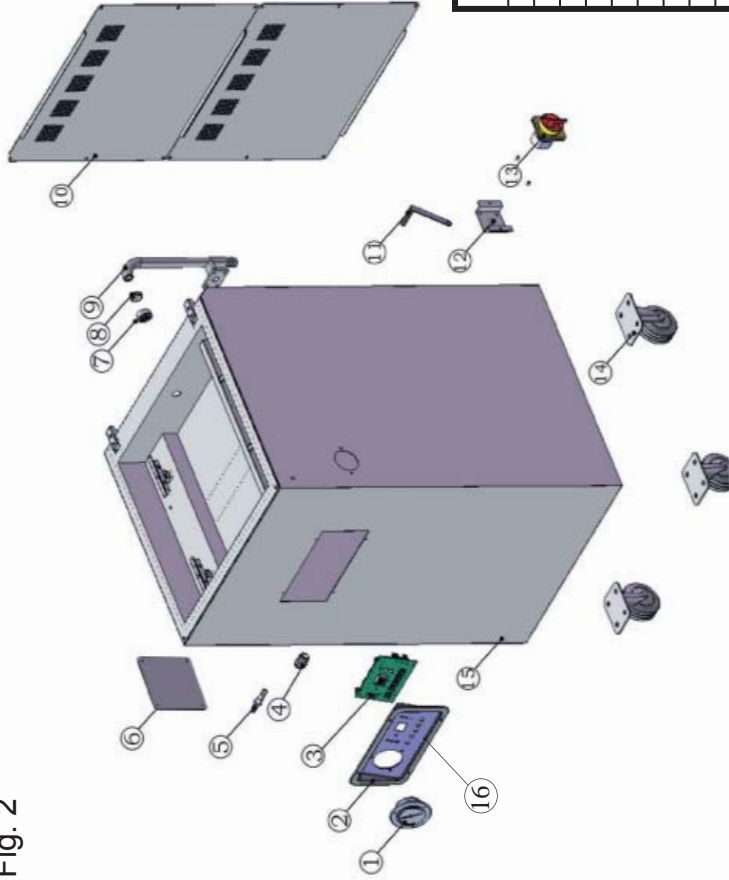

Name	Quantity	Part Number	Assembly Part Number
1 Vacuum Gauge	1	979126	
2 Instrument Panel	1	979125	
3 Circuit Board	1	979127	
4 Cable Sheath	1		
5 Straight-Way Connector	1		
6 Cover Plate	1		
7 Inlet Ring*	1		
8 Inner Inlet Ring*	1		
9 Exhaust Tube*	1		
10 Rear Cover	1		
11 Buckle on Cover	1		
12 Power Switch Bracket	1	979137	
13 Power Switch	1	979138	
14 Casters	4	979395	
15 Housing Case	1		
16 Decal, Instrument Panel	1	979124	

\*Part of Chamber

Fig. 3

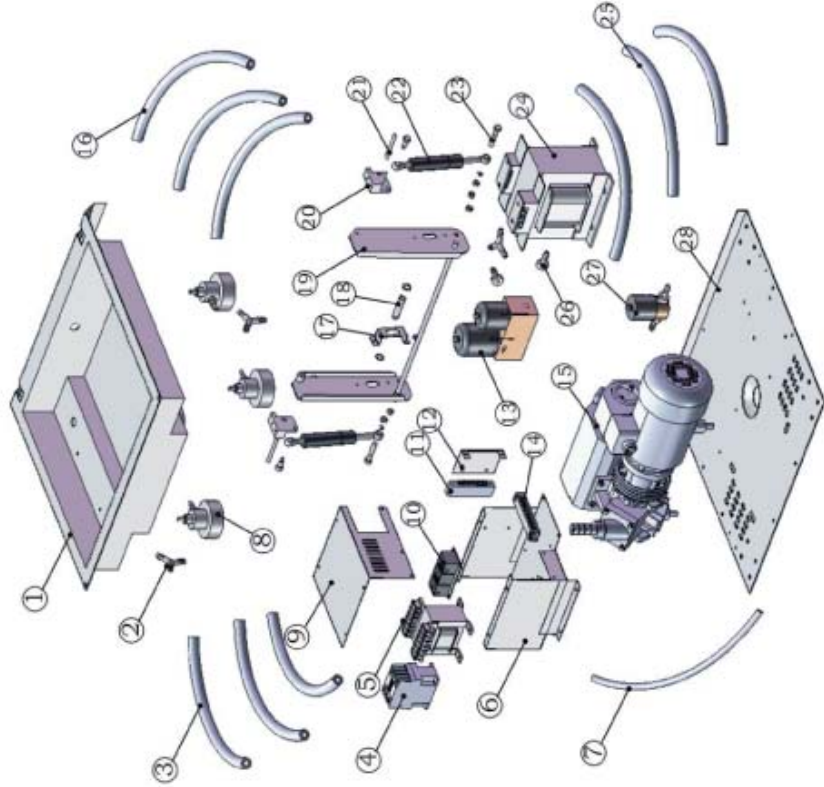

Name	Quantity	Part Number	Assembly Part Number
1 Vacuum Chamber	1		
2 Three-Way Connector	1		
3 Silicone Rubber Tube	1		
4 Intermediate Relay	1	979141	
5 Control Transformer	1	979139	
6 Housing for Electrical Box	1		
7 Silicone Rubber Tube	1		
8 Piston	4	979380	
9 Cover for Electrical Box	1		
10 Connecting Terminal	1		
11 Circuit Board Port	1		
12 Frame for Wire Holder	1		
13 Solenoid Combined Valve	1	979560	
14 Wiring Port	1		
15 Vacuum Pump	1	979320	
16 Silicone Rubber Tube	1		
17 Proximity Switch Seat	1	979354	
18 Proximity Switch	1	979355	
19 Lid Hinge Support	2		Lid Hinge Assembly (979352)
20 Lid Hinge	2		
21 Lid Hinge Pin	2		
22 Gas Shock	2	979356	
23 Screw & Nut Lower	2	979357	
24 Sealing Transformer	1	979341	
25 Silicone Rubber Tube	1		
26 Through-Tube	1		
27 Solenoid Valve	1	979365	
28 Bottom Plate	1		
29 Shoulder Bolt Upper	2	979358	



## Notes

## Limited Warranty

ARY, Inc. a distributor and manufacturer of vacuum packaging and other machines (collectively, the "Goods"), extends to the purchaser of the Goods a Limited One Year Warranty, from the receipt of the Goods, under terms and conditions set out herein.

All Goods sold by ARY, Inc. are warranted to be free from defects in material and workmanship at the time of delivery to purchaser. Defective material may be returned to ARY, Inc. after inspection by an agent of ARY, Inc. and upon receipt from ARY, Inc. of shipping instructions specific to the defective Goods authorized by ARY, Inc. to be returned. ARY, Inc. at its sole option, may either (i) replace or repair any defective materials and workmanship (and return the Goods to purchaser without charge), (ii) refund the purchase price, or (iii) grant a reasonable allowance with the foregoing procedure.

This warranty is subject to the following limitations:

- i. ARY, Inc.'s responsibility and the purchaser's exclusive remedy under this warranty is limited to the repair or replacement of defects in material and workmanship, refund of the purchase price, or grant of a reasonable allowance on account of such defects, all as set forth above. ARY, Inc. is not responsible for any consequential damages resulting from the breach of this or any other express or implied warranty with respect to the Goods.
- ii. This express warranty is the only warranty applicable. It excludes all other express oral or written warranties and all warranties implied by law with respect to the Goods, including any warranties or merchantability or fitness for a particular purpose.
- iii. Every claim under this warranty shall be deemed waived by purchaser unless made in writing within one (1) year of the receipt of the Goods to which such claim relates.
- iv. This warranty, as to the Goods, is void (a) to repairs made by anyone other than ARY, Inc. without prior authorization from ARY, Inc., (b) to performance of any system of which ARY, Inc.'s Goods are a component part, (c) to deterioration by corrosion or any cause of failure other than defect of material or workmanship, (d) to any components of the Goods, including, without limitation, Teflon tape, lid gaskets and seal wire, or (e) if any of the Good or parts thereof have been tampered with or altered by someone other than ARY, Inc., or subjected to misuse, neglect, abuse, or misuse in application.

ARY, Inc.'s maximum liability hereunder, arising from any cause whatsoever, whether based in contract, tort (including negligence), strict liability, or any other theory of law, shall not exceed the purchase price. A suit based on any aforementioned cause of action must be commenced within one year from the date said action accrues.



A leading supplier of commercial products since 1939.

ARY, Inc.  
P. O. Box 412888  
Kansas City, MO 64141  
800.821.7849

All Rights reserved. GameMaster™, VacMaster®, VacStrip®, Total Freshness System™ and Commercial Culinary Concepts are trademarks or registered trademarks of ARY, Inc. in the United States and other countries.

Patent #5,239,808

---

\* VACUUM PACKAGING IS NOT A SUBSTITUTE FOR CANNING.